

ofinto

Ergonomic Chair Ergo

User Manual



THANK YOU!

Thank you for choosing the ofinto ergonomic chair **Ergo**! The chair offers you optimal support for active, dynamic sitting and ergonomic working. The ergonomic chair **Ergo** combines ergonomics with comfort and enables a healthy posture while sitting. However, only if your chair is correctly assembled, configured and customized can it fulfill all ergonomic aspects. This User Manual is intended to help you with these settings.

Your feedback is important to us! Please leave us your rating for the ofinto ergonomic chair **Ergo** online at www.ofinto.co.uk. If you have any questions, comments, requests for additions or suggestions for improvement, please feel free to contact us at any time via our online customer service. We would be pleased to hear from you.

And now have fun sitting!



WARNING!

Please read the instructions and safety precautions carefully before using the office chair. Keep the assembly instructions for further use. If you pass on the swivel chair to a third party, make sure to include these assembly instructions.

ofinto ag assumes no liability for damage caused by the improper use of the office chair.

DELIVERY CONTENTS

COMPONENTS & TOOLS

A

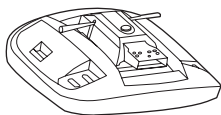

B

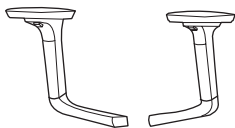

C

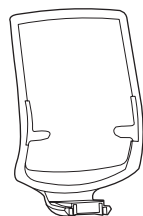

D



E

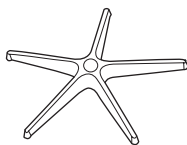

F

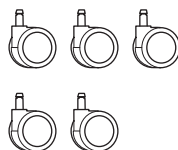

G

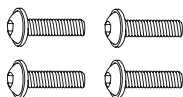

H

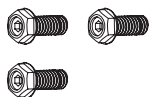

I

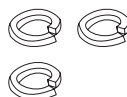

J

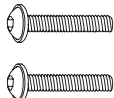

K



L



A Seat & Mechanism

B Armrests

C Backrest

D Gas spring

E Footbase

F Castors

G Screws M6*40mm

H Screws M8*20mm

I Split lock washers 8*13mm

J Screws M6*45mm

K Washers 8*20mm

L Hex key 5mm

ASSEMBLY

Help and videos regarding the assembly can be found here:



Step 1

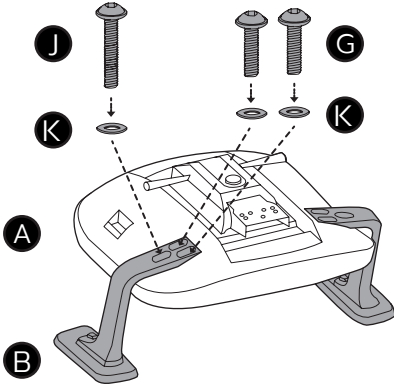

Step 3

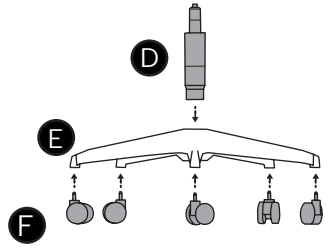

i Press castors firmly into the footbase!

Step 2

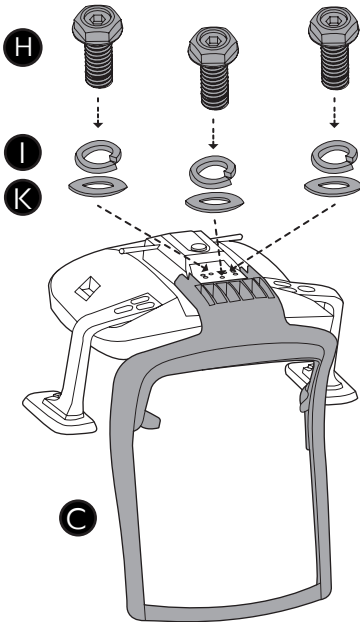

Step 4

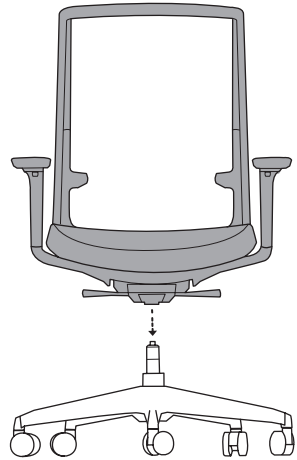

CONTROLS

Videos regarding the controls of the chair can be found here:



SEAT HEIGHT

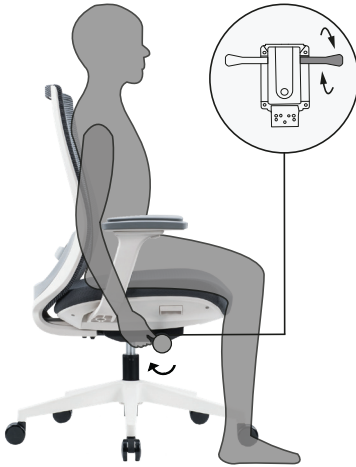

SEAT DEPTH



ARMRESTS

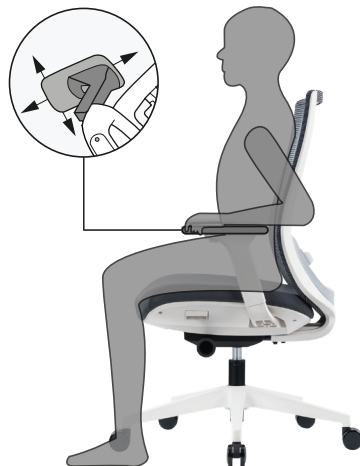

LUMBAR SUPPORT



BACKREST

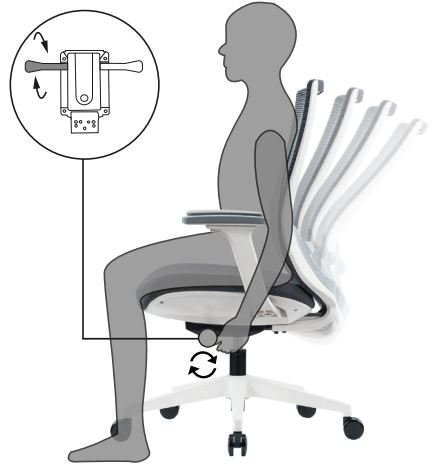

CORRECT SETUP

You can adjust the swivel chair in seat height, seat depth and backrest inclination. This enables you to achieve an ergonomic sitting position. An upright sitting posture strengthens your spine. Make sure that you place your legs at an angle of slightly more than 90° and your feet completely on the floor. The **seat height** is correctly adjusted when your knee is slightly lower than your hip.

The length of your legs determines the **seat depth**. It is correctly adjusted when there is a distance of about three fingers between the edge of the seat and the calf when the pelvis is in very good contact with the backrest.

Adjust your **armrests** so that both shoulders are horizontal in a relaxed position while your forearms rest on the armrests. The arm angle should be at least 90°.

The width of the armrests depends on the width of your shoulders. When adjusted correctly, your arms are close to your torso while resting on the armrests. However, your freedom of movement must not be restricted.

Adjust the height of the **lumbar support** so that the strongest tension of the seat fabric is at the level of the lumbar vertebrae, i.e. approximately on the waistline. The lumbar support helps relieve pressure on your spine when sitting for long periods of time and supports your lower back in its natural shape.

Your chair has a resistance mechanism that automatically adjusts to your body weight. So, the **backrest** will always provide you with ideal support as you move forward and backward due to the automatic resistance. In general, it is healthier to move around while sitting, so put the back of your chair in a moving position. This extra movement can help prevent the detrimental effects of sitting all day.

PRODUCT SPECIFICATIONS

WEIGHT & DIMENSIONS

| | |
|-----------------|---------------------------|
| Product weight: | approx. 17 kg |
| Max. load: | 130 kg |
| Chair height: | min. 98 cm max. 108 cm |
| Seat height: | min. 43 cm max. 53 cm |
| Seat depth: | min. 46 cm max. 51 cm |
| Backrest: | 45 cm x 55 cm (W x H) |

SPECIFICATIONS

- Soft castors for hard floors (see next page)
- Synchronous inclination adjustment (synchronous mechanism) with locking button
- 4 tilt lock positions with anti-shock lock
- Seat slide function with 5 cm adjustment
- Adjustable lumbar support
- Class 4 gas spring with a stroke of approx. 10 cm (TÜV LGA tested according to DIN EN 16955:2017)
- Durability certified according to ANSI/BIFMA X5.1-2017 safety standard (Type I, III)
- Ergonomics certified by IGR Institute for Health and Ergonomics according to DIN EN ISO 26800 / EN ISO 15537

SAFETY INSTRUCTIONS AND HAZARD WARNINGS

Only trained technicians may work on or replace gas springs for adjusting the seat height. They may never be replaced or repaired independently by the user. In case of independent repairs, liability and warranty claims expire. In addition, personal injury and damage to property may occur. ofinto ag does not accept any liability for damage caused by improper or incorrect use.

The office swivel chair is designed exclusively as a seating option for individual persons with a maximum weight load of 130 kg. It must never be used as a substitute for a ladder, as a stand, as a gymnastics apparatus for children or similar.

Proceed carefully during installation and follow these installation instructions. Improper assembly, as well as failure to comply with or disregard the instructions and warnings regarding the use of this product may result in damage to property and/or injury.

Place the swivel chair indoors only and always place it on a level and dry floor. Plastic and metal react to stress and temperature influences by expanding and contracting. Check all screw connections regularly and tighten them if necessary. Loose screw connections can lead to personal injury. Do not use the swivel chair if screw connections have become loose or if the metal or plastic parts are deformed, cracked or otherwise damaged.

The chair is equipped with high-quality polyetherane castors. These are suitable for hard as well as soft floors. For particularly delicate floors we recommend the use of a floor protection mat. ofinto is not liable for any damage to the floor.

Do not have the swivel chair dismantled by non-instructed persons. This can lead to injury or damage.

Do not expose the swivel chair to weather conditions, e.g. rain. Protect the office chair from direct sunlight, otherwise the color of the textiles may change. Also remember that zippers, sharp-edged buttons or rivets on garments may cause damage to the cover.

Individual parts such as armrests or castors may only be replaced independently after consultation with the ofinto customer service.

CARE INSTRUCTIONS

CLEANING

A vacuum cleaner can be used to remove dust and lint from the cover. Use a damp soft cloth and a mild, neutral detergent to treat stains on the cover and the surface. For stubborn stains please consult a specialist.

Use a dry cloth to remove dust and dirt from the underside of the seat, the back of the backrest and the base.

Do not use aggressive cleaning agents, hard brushes, sharp or metallic cleaning objects such as knives, metal sponges and the like. These can damage the surfaces. Never clean the gas pressure spring.

MAINTENANCE

Occasionally remove dust and carpet fluff from the castors to ensure that the castors can move.

Regularly check all screw connections for tightness and tighten them if necessary. Loose screw connections impair safety and there is a risk of injury.

Before using or storing the swivel chair again, wait until all parts are completely dry or dry them with a dry cloth.

STORING AND DISPOSAL

STORING

All parts must be completely dry before storing.

Always store the office chair in a dry place, protected from dust and inaccessible to children.

DISPOSAL

Keep packaging materials away from children and recycle them in the interest of environmental protection. Add cardboard and paperboard to the waste paper, foils to the recyclable material collection.

When the chair is no longer of use, contact your local waste disposal service for information on environmentally friendly disposal. By disposing of the chair separately, you can help reduce waste and reduce potential negative impact on human health and the environment.

This page is intentionally left blank

ofinto

Bischofszellerstrasse 53
CH-9200 Gossau SG
info@ofinto.co.uk | www.ofinto.co.uk